

- S1200 – 1.20x1.20 m
- S1700 – 1.70x1.70 m

S1200

 15 m \longrightarrow 55 m

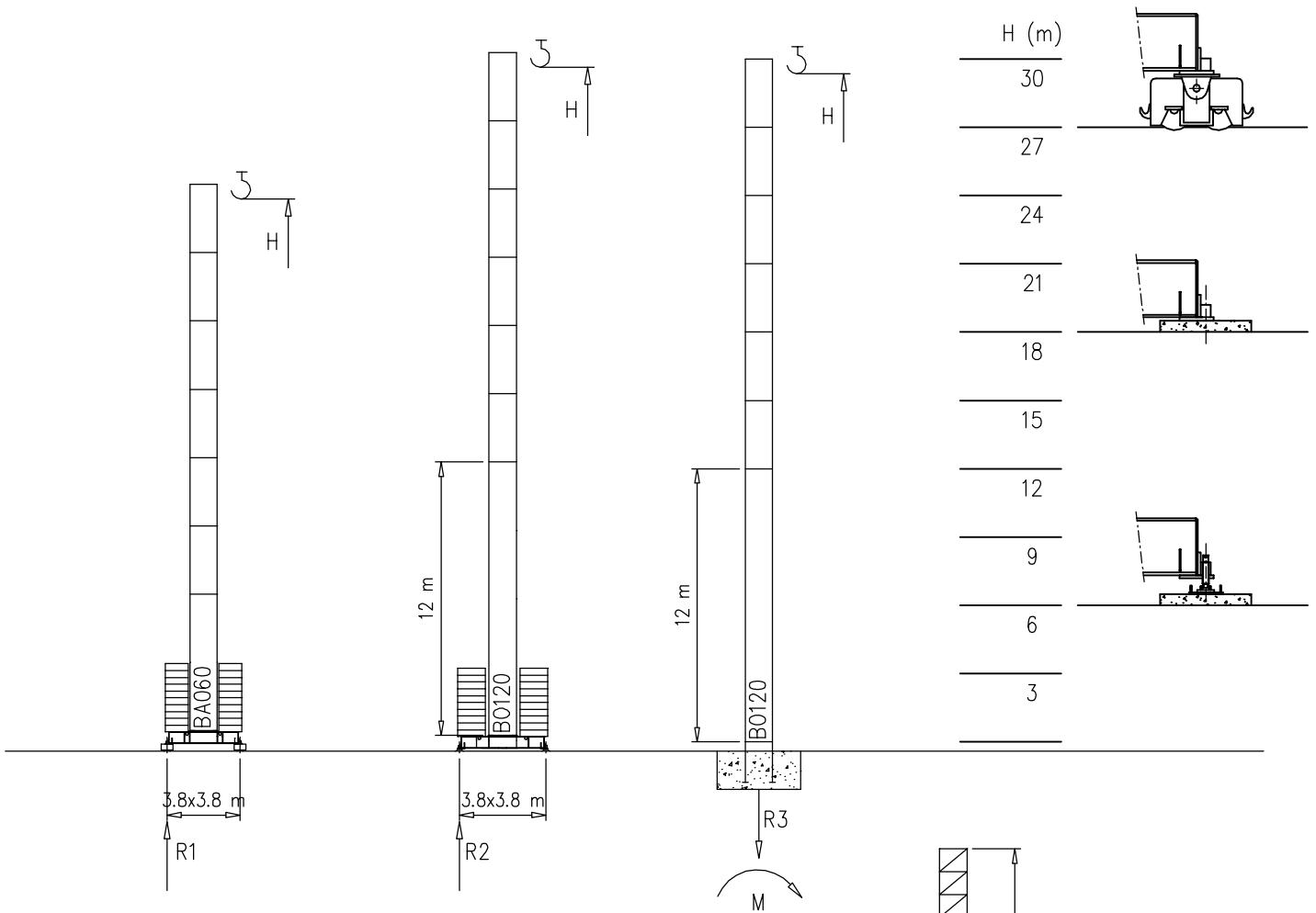

H=16–30 m		H=0–15 m	
R1		R1	53 t
R2	69 t	R2	53 t
R3	40 t	R3	25.6 t
M	185 tm	M	116 tm

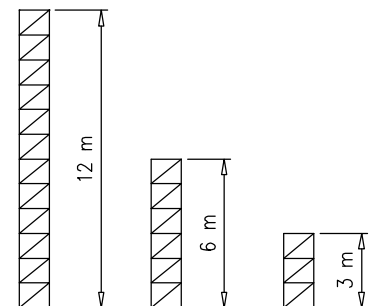

Peso zavorra – Ballast weight – Poids du lest – Ballastgewicht – Peso de lastre

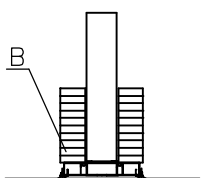

H	n°	Tot.
0–15 m	18 B	54000 kg
16–30 m	24 B	72000 kg

	B
L	4.0m
k	0.19m
d	1.2m

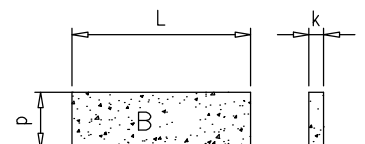

Torre/Reazioni – Masts/Reactions – Mat/Réactions – Maste/Eckdrücke – Măstil/Reacciones – Tramo/Reacções

S1700

 15 m —> 55 m

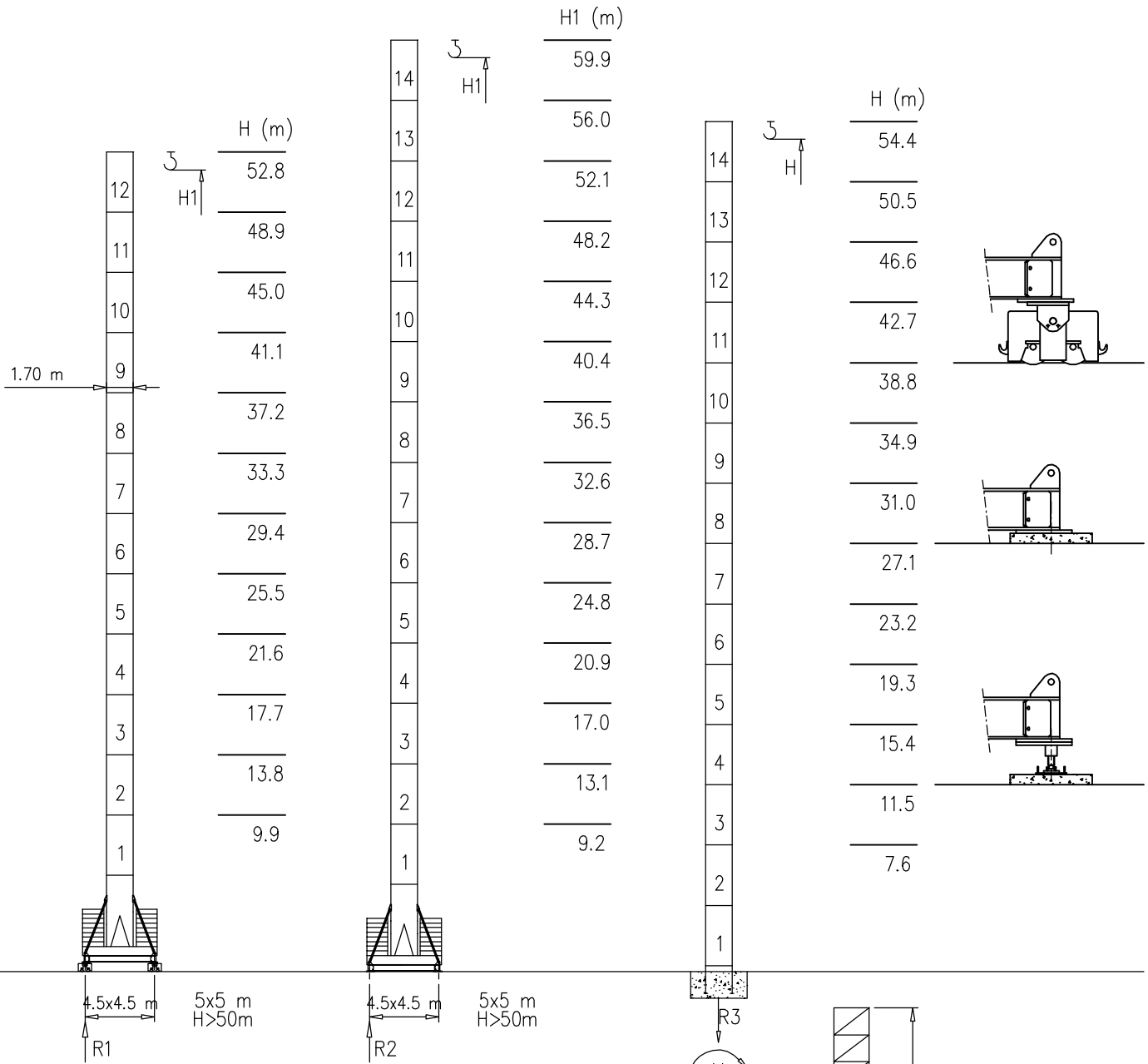

H=46-58 m		H=36-45 m		H=0-35 m	
R1	106 t	R1	72 t	R1	65 t
R2	106 t	R2	72 t	R2	65 t
R3	95 t	R3	61 t	R3	54 t
M	336 tm	M	194 tm	M	156 tm

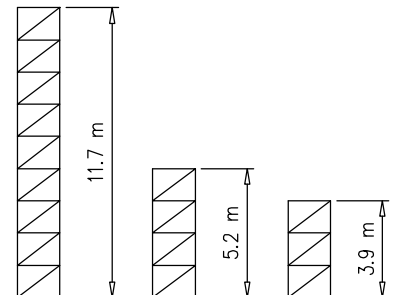





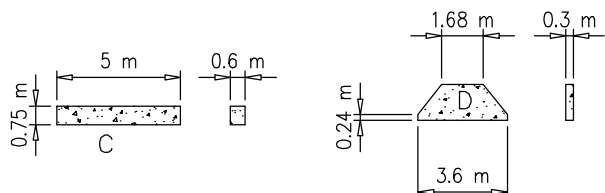













Peso zavorra – Ballast weight – Poids du lest – Ballastgewicht – Peso de lastre

H	n°	Tot.
0-35 m	2C+ 18D	60800 kg
36-45 m	2C+ 22D	72000 kg
46-58 m	2C+ 34D	105550 kg





















Curve di carico – Courbes de charges – Load diagrams – LastKurven – Curvas de cargas

Pmax 3000 kg

	16800 kg		55 m	2	30	32.5	35	37.5	40	42.5	45	47.5	50	52.5	55	m
				3000	3000	2750	2510	2310	2120	1970	1850	1690	1580	1450	1300	kg
	14400 kg		50 m	2	31	32.5	35	37.5	40	42.5	45	47.5	50			m
				3000	3000	2960	2700	2480	2290	2120	1970	1830	1600			kg
	12000 kg		45 m	2	34	35	37.5	40	42.5	45						m
				3000	3000	2940	2720	2500	2300	2000						kg
	10800 kg		40 m	2				37.5	40							m
				3000				3000	2600							kg
	10800 kg		35 m	2			35									m
				3000			3000									kg
	9600 kg		30 m	2			30									m
				3000			3000									kg
	8400 kg		25 m	2			25									
				3000			3000									
	7200 kg		20 m	2			20									
				3000			3000									
	4800 kg		15 m	2		15										
				3000		3000										



Pmax 6000/3000 kg

	16800 kg		55 m	2	16.5	17.5	20	22.5	25	27.5	30	32.5	35	37.5	40	42.5	45	47.5	50	52.5	55	m
				6000	6000	5640	4850	4250	3760	3370	3030	2750	2510	2310	2120	1970	1850	1690	1580	1450	1300	kg
	14400 kg		50 m	2		17.5	20	22.5	25	27.5	30	32.5	35	37.5	40	42.5	45	47.5	50			m
				6000		6000	5200	4550	4030	3610	3250	2960	2700	2480	2290	2120	1970	1830	1600			kg
	12000 kg		45 m	2		19	20	22.5	25	27.5	30	32.5	35	37.5	40	42.5	45					m
				6000		6000	5600	4920	4350	3900	3530	3210	2940	2720	2500	2300	2000					kg
	10800 kg		40 m	2		21	22.5	25	27.5	30	32.5	35	37.5	40								m
				6000		6000	5480	4860	4370	3950	3600	3300	3000	2600								kg
	10800 kg		35 m	2		22	25	27.5	30	32.5	35											m
				6000		6000	5250	4740	4260	3900	3300											kg
	9600 kg		30 m	2		24	25	27.5	30													m
				6000		6000	5700	5000	4300													kg
	8400 kg		25 m	2		20	22.5	25														
				6000		6000	5250	4300														
	7200 kg		20 m	2		16	17.5	20														
				6000		6000	5400	4300														
	4800 kg		15 m	2		12	15															
				6000		6000	4300															



Montaggio – Montage – Erection – Montage – Montaje – Montagem

X (m)	kg
3,8x3,8	4500kg
4,5x4,5	3800kg





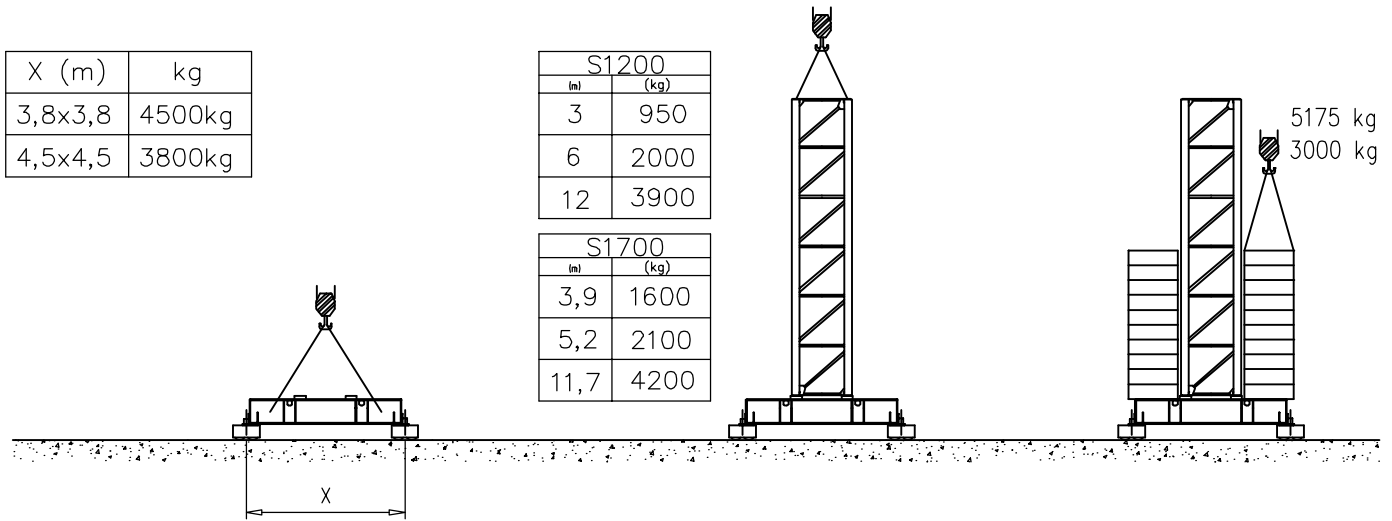



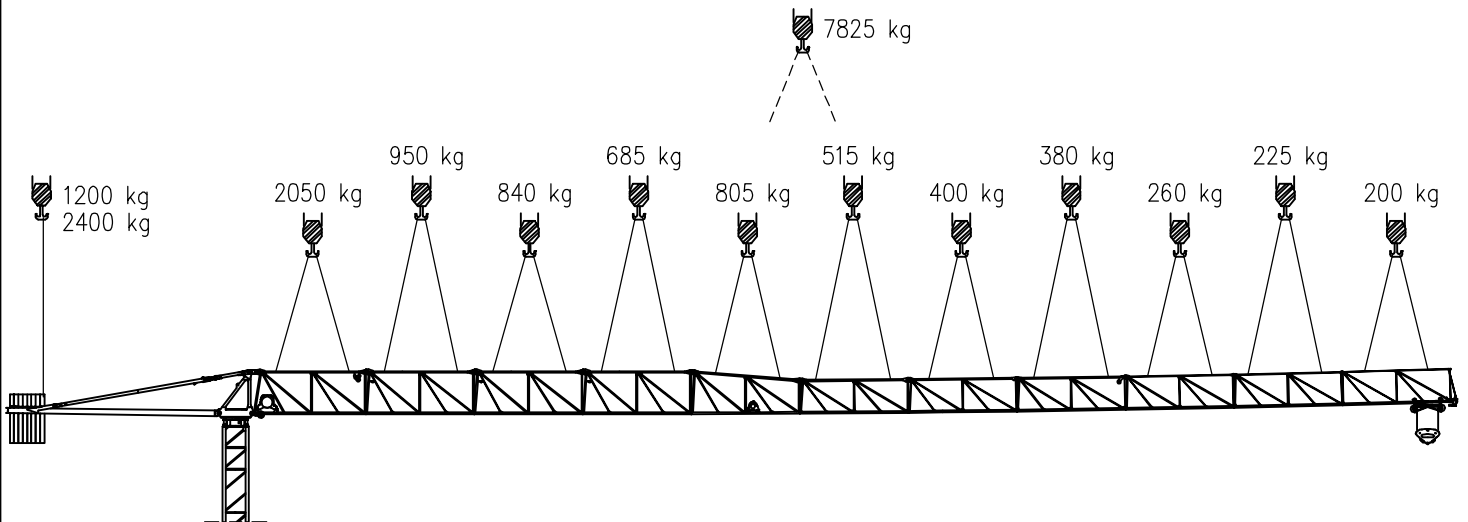
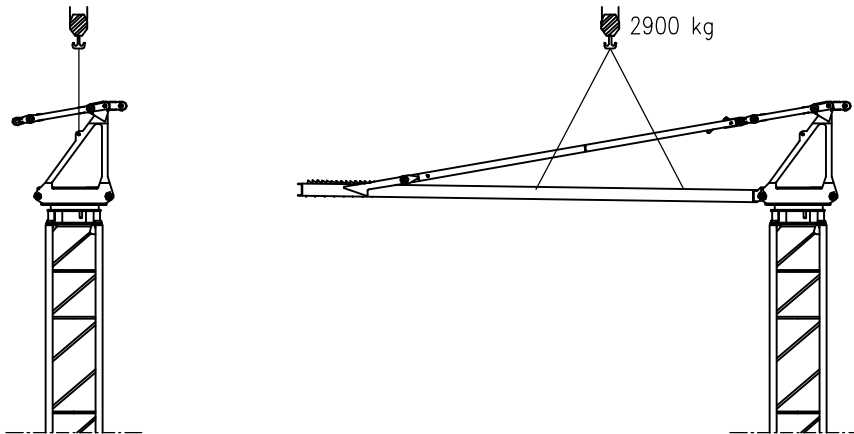

S1200	
inl	(kg)
3	950
6	2000
12	3900

S1700	
inl	(kg)
3,9	1600
5,2	2100
11,7	4200



Torre	kg
S1700	5000 kg
S1200	3500 kg

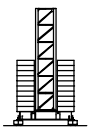

Sollevamento V25.60 Hoisting Levage Heben Elevaciòn Elevaçao			1a	7 m/min	3000 kg	18.5 kW	V25.60 33 kVA					
			2a	18 m/min	3000 kg							
			3a	28 m/min	3000 kg							
			4a	42 m/min	2250 kg							
			5a	56 m/min	1500 kg							
			1a	3.5 m/min	6000 kg							
			2a	9 m/min	6000 kg							
			3a	14 m/min	6000 kg							
			4a	21 m/min	4500 kg							
			5a	28 m/min	3000 kg							
Sollevamento V33.90 Hoisting Levage Heben Elevaciòn Elevaçao			1a	3 m/min	3000 kg	22 kW	V33.90 42 kVA					
			2a	18 m/min	3000 kg							
			3a	34 m/min	3000 kg							
			4a	54 m/min	1800 kg							
			5a	70 m/min	1300 kg							
			6a	90 m/min	500 kg							
			1a	1.5 m/min	6000 kg							
			2a	9 m/min	6000 kg							
			3a	17 m/min	6000 kg							
			4a	27 m/min	3600 kg							
			5a	35 m/min	2600 kg							
			6a	45 m/min	1000 kg							
			Carrello Trolleying Distribution Katzfahren Distribuciòn Distribuiçao					1a	OP 5 m/min	6000 kg	3 kW	Potenza elettrica necessaria Puissance électrique nécessaire Necessary electric power Anschlusswert – Potencia
								2a	25 m/min	6000 kg		
3a	50 m/min	3000 kg										
Rotazione Slewing Orientation Schwenken Orientaciòn Rotaçao			1a	0 → 0.2	giri/min tr/min rp/min	4.4 kW @ 1200rpm n° 2 x 2.2 kW						
			2a	0 → 0.6								
			3a	0 → 0.9								
Traslazione Travelling Translation Kranfahren Traslaciòn Traslaçao			1a	OP 0 → 5	3.7 kW							
			2a	0 → 20								

Rete elettrica – Réseau – Mains supply – Netzstrom – Red – Rede electrica	400V – 50 Hz
---	--------------

 FMgru s.r.l. via Emilia 11-29010 Pontenure PC ITALY tel. 0523/510446 ric.aut. fax 0523/510365 www.fmgru.com e-mail: info@fmgru.com

FEM 1.001 2000/14/CE



Documento commerciale non contrattuale
Per tutte le informazioni tecniche riferirsi
alle corrispondenti istruzioni

Unverbindliches Vertriebsdokument.
Für technische Informationen, siehe die
entsprechenden Anweisungen.

This commercial document is not legally
binding. For any technical information, please
refer to the corresponding instructions.

Documento comercial no contractual
Para cualquier información técnica,
ver la noticia correspondiente.

Code: 15/CA37T35A0		
Ed.	Data	Rev Data
1	10.01.07	1 18.12.07