

724 RBI – H19m – P 700 kg a 24 m Pmax 1800 kg

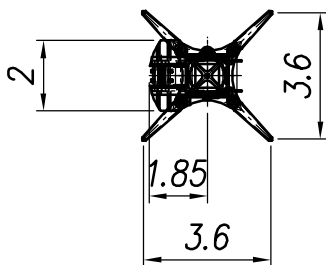

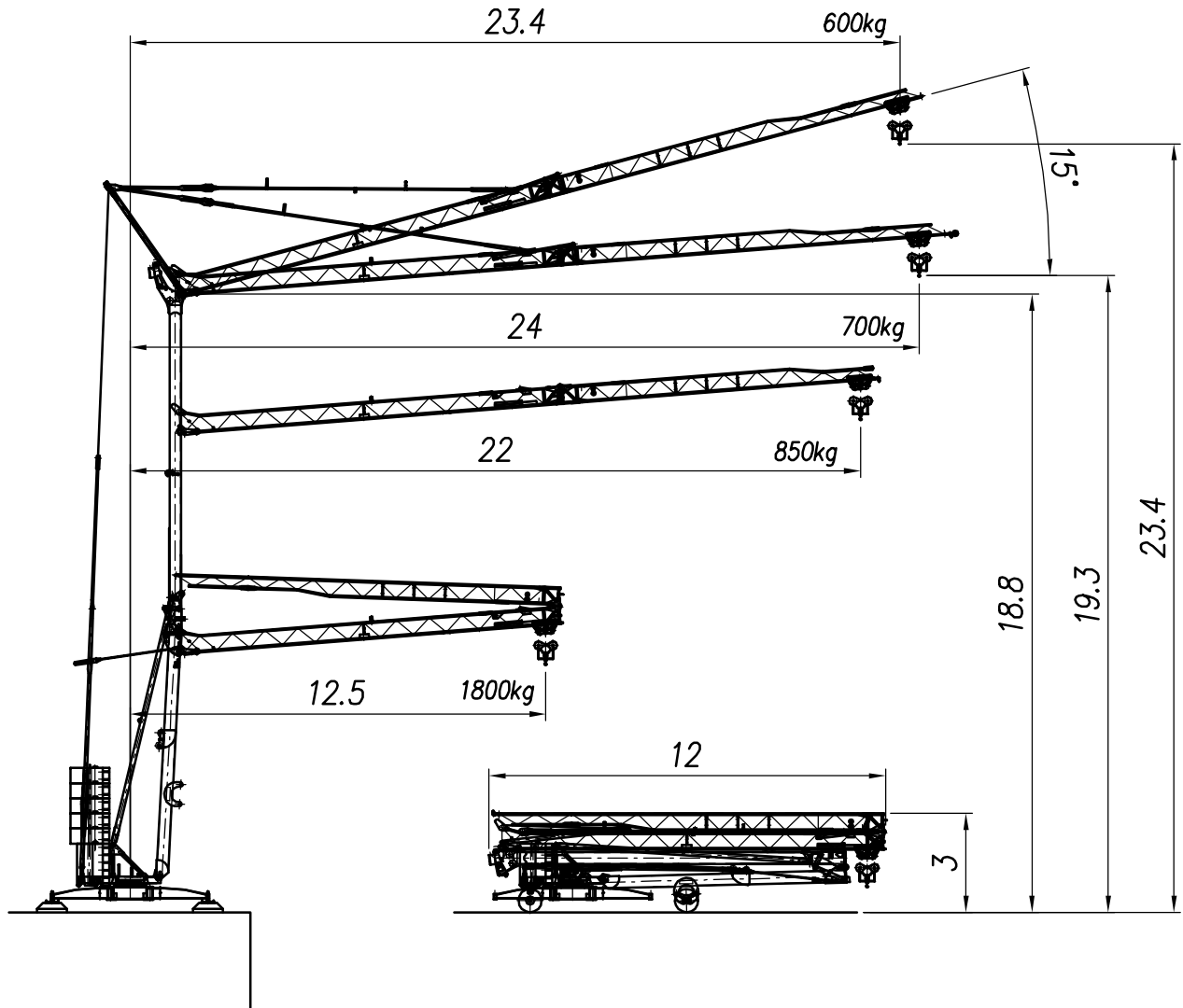



11,2	12	16	20	24	m
1800	1650	1155	875	700	kg



11,93	12	16	20	22	m
1800	1785	1250	955	850	kg

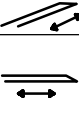

Meccanismi – Mecanismos – Mechanisms – Antriebe – Mecanismos – Montagem

Sollevamento Levage Hoisting Heben Elevaciòn			1a	4 m/min	1800 kg	5.5 kW
			2a	16 m/min	1800 kg	
			3a	32 m/min	900 kg	
Distribuzione Distibution Trolleying Katzfahren Distribuciòn			2a	30 m/min	1.83 kW	
			1a	15 m/min		
			2a	30 m/min		
Rotazione Orientation Slewing Schwenken Orientaciòn			0-0.8 giri/min tr/min rpm		2.2 kW	

Rete elettrica – Rèseau – Mains supply – Netzstrom – Red – Rede eletrica	400V-50Hz
--	-----------

Potenza elettrica necessaria – Puissance électrique nècessaire Necessary electric power – Anschlusswert – Potencia elettrica necesaria	3PH 12kVA 1/3PH 11kVA
---	--------------------------